

évolur

evolving with your baby

INFINITY

Compact Stroller

MODEL NO.: 478 USER MANUAL

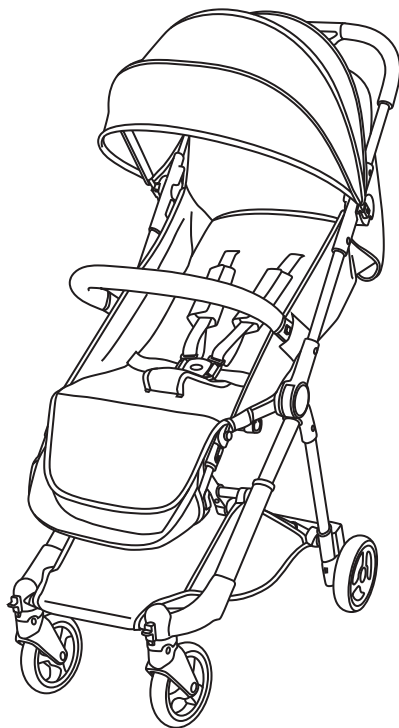

Scan the QR code to register your product

<https://www.evolorbaby.com/customer-care/product-registration/>



Important: Keep these instructions for future reference.

Safety

• Cozy Fashion

WARNING

Thank you for choosing Dream On Me and congratulations on joining The DOM Family, a family that has been transforming lives for 30 years! We appreciate your feedback and wish you the very best in the coming years with your new addition. If you have any questions or concerns please don't hesitate to reach out and a trusted DOM representative will assist you. Thank you again for entrusting us to supply you with the safest, functional and affordable baby products and accessories. Feel free to follow us on Facebook and Instagram for further opportunities and offers.

Failure to follow these warnings and the assembly instructions could result in serious injury or death.

- **ADULT ASSEMBLY REQUIRED.**
- **NEVER LEAVE CHILD UNATTENDED.** Always keep child in view while in stroller.
- **AVOID SERIOUS INJURY** from falling or sliding out. Always use seat belt. After fastening buckles, adjust belts to get a snug fit around your child.
- **AVOID FINGER ENTRAPMENT:** Use care when folding and unfolding the stroller. Be certain the stroller is fully erected and latched before allowing your child near the stroller.
- **NEVER USE STROLLER ON STAIRS** or escalators. You may suddenly lose control of the stroller or your child may fall out. Also, use extra care when going up or down a step or curb.
- **DO NOT** place items with a string around your child's neck, suspend strings from this product, or attach strings to toys.
- **USE OF THE STROLLER** with a child weighing more than 40 lb (18 kg) or taller than 45 inches(114.3cm) will cause excessive wear and stress on the stroller. Use the stroller with only one child at a time.
- **TO PREVENT A HAZARDOUS, UNSTABLE CONDITION**, never place purses, shopping bags, parcels or accessory items on the handle. Never place anything on the canopy.
- **TO PREVENT A HAZARDOUS, UNSTABLE CONDITION**, do not place more than 10 lb (4.5 kg) total in the storage basket.
- **DO NOT** use storage basket as a child carrier.
- **DO NOT ALLOW** your child to stand on the basket. It may collapse and cause injury.
- **NEVER PLACE** child in the stroller with head toward footrest.
- **NEVER ALLOW YOUR STROLLER** to be used as a toy.
- **DISCONTINUE USING YOUR STROLLER** should it become damaged or broken.
- **STROLLER TO BE USED** only at walking speed product not intended for use while jogging, skating, etc.
- **CAREGIVER MUST** always help child get into and out of the stroller.

WARNING

THE STROLLER IS DESIGNED FOR USE ON FLAT OR GENTLY SLOPING SURFACES, AND MAY BE UNSTABLE ON HIGHER SLOPING AND UNEVEN SURFACES. USERS SHOULD BE AWARE OF THE POSSIBILITY OF THE STROLLER ROLLING AWAY OR TIPPING OVER.

- PUSH THE STROLLER HOLDING BOTH HANDS.
- THE STROLLER CAN BE STEERED IN THE DESIRED DIRECTION - ALLOWING THE FRONT WHEELS TO SWIVEL WILL MAKE THIS EASIER.
- THE FRONT WHEELS MAY WOBBLE OR OSCILLATE WHEN WALKING FAST. LOCKING THE FRONT SWIVEL WHEELS WILL FIX THEM IN POSITION.
- THE STROLLER CAN BE TAKEN UP CURBS BY EITHER PUSHING DOWN ON THE HANDLE BAR, THEREBY RAISING THE FRONT WHEELS AND MOUNTING THEM ON THE CURB. OR, YOU CAN TURN THE STROLLER AROUND AND PULL THE STROLLER UP THE CURB.
- CAUTION IS REQUIRED WHEN PUSHING THE STROLLER ACROSS STEEP SLOPES OR UNEVEN SURFACES THIS MAY CAUSE STROLLER TO BECOME UNSTABLE AND FALL OVER. ALWAYS HOLD THE HANDLE BAR FIRMLY.
- WHENEVER YOU STOP, ALWAYS APPLY THE BRAKES BEFORE YOU LEAVE THE STROLLER.
- DO NOT HANG BAGS OR GOODS FROM THE HANDLE BAR, AS THIS COULD CAUSE THE STROLLER TO TIP OVER. USE THE STORAGE BASKET.

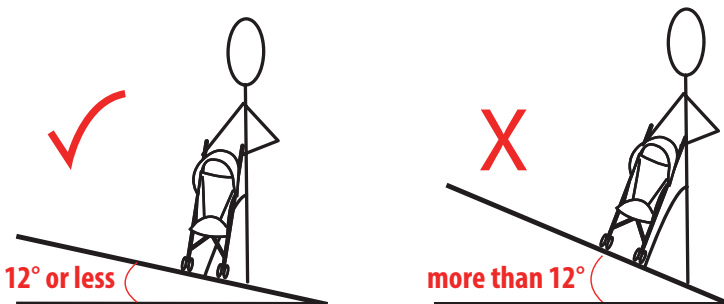

WARNING

- THE UPRIGHT POSITIONS ARE NOT SUITABLE FOR A CHILD UNDER 6 MONTHS OLD.
- THE LOWEST RECLINE POSITION SHOULD BE USED TO TRANSPORT BABIES. THE BACKREST CAN BE ADJUSTED TO A MORE UPRIGHT POSITION AS THE CHILD GROWS OLDER AND IS ABLE TO SUPPORT ITS HEAD WITHOUT ASSISTANCE.



CARE AND MAINTENANCE

- To prolong the life of your stroller, keep it clean and do not leave it in the direct sunlight or in the car for extended periods of time.
- Removable fabric covers and trims may be cleaned using warm water with a household soap or mild detergent. Allow it to dry fully, preferably away from the direct sunlight.
- Non removable fabric covers and trims may be spot cleaned using a damp sponge with soap or a mild detergent. Allow it to dry completely before folding or storing it away.
- In some climates, the covers and trims may be affected by mold and mildew. To help prevent this occurring, do not fold or store the product if it is damp or wet.
- Always store the product in a well ventilated area.
- When using your stroller at the beach, completely clean your stroller afterwards to remove any sand and salt from the mechanisms and wheels. Sand and salt will cause premature wear and corrosion.
- If there are compression marks on the tires, use a domestic hair dryer to gently warm (DO NOT OVERHEAT) the tire and the compression marks should slowly disappear.
- Always check parts regularly for tightness of screws, nuts, and other fasteners. Tighten if required. To maintain the safety of your Infinity Stroller, seek prompt repairs for bent, torn, worn or broken parts by contacting Evolur.

Dream On Me Inc.

1532 S Washington Ave, Piscataway TWP, NJ 08854

Tel: 732-752-7220

Fax: 732-752-7221

MADE ZHONG SHAN, CHINA







CAUTION

This CAUTION Symbol is shown at certain steps in this Instruction Manual to highlight the danger of being injured by moving parts.

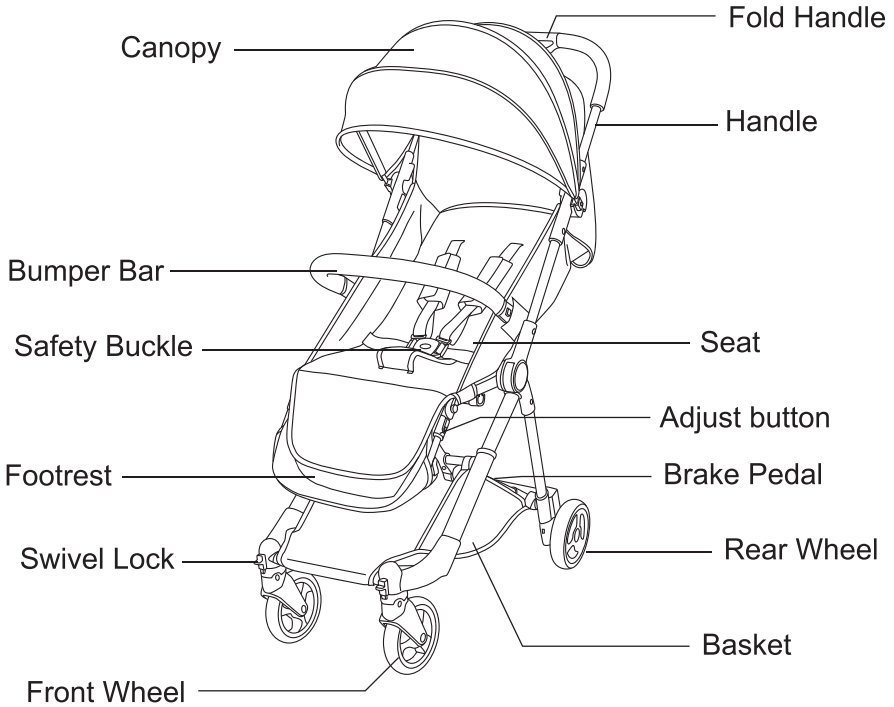
Parts list

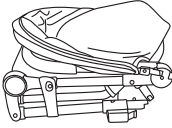
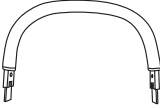
Please check to make sure that all of the following parts listed are included in the box when opened. If there are any missing parts, please contact Evolur before using the Infinity Stroller.



 Frame x1	 Bumper Bar x1	 Front Wheel x2
 Rear Wheel (R) x1	 Rear Wheel (L) x1	

1. To Open Stroller

(1) Open storage latch, refer to Fig. A

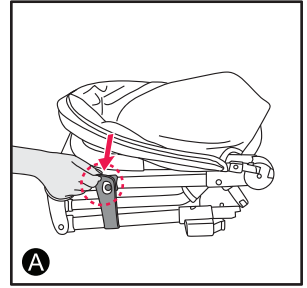

(2) Lift up the handle of stroller, refer to Fig. B & C

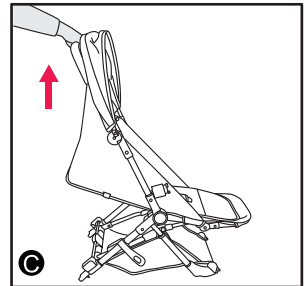
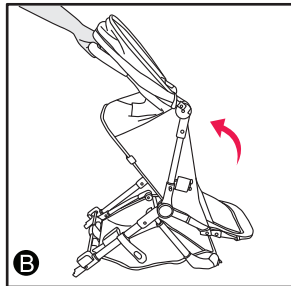

(3) Hold the Gray Lock Pedal, then lift handle of stroller up until hear a “Click”, refer to Fig D.
CHECK that the stroller is completely latched open every time you open the stroller and before continuing with the rest of the assembly steps.

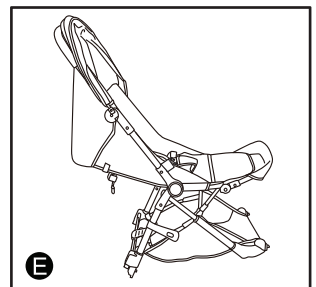
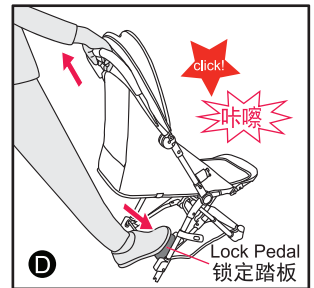

2. Front Wheels

(4) Slide each front wheel into the mounting post at the front of the stroller until you hear a "click" (Fig. A). Pull each wheel to **CHECK** and ensure that they are secure.

For easy transport or storage, Push the wheel release tab on the inside of the stroller frame and pull the wheel off of the stroller (Fig. B).

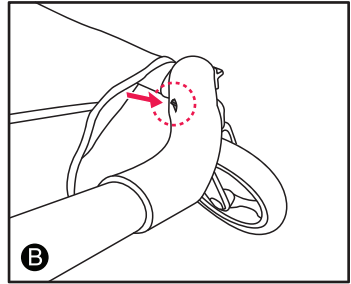
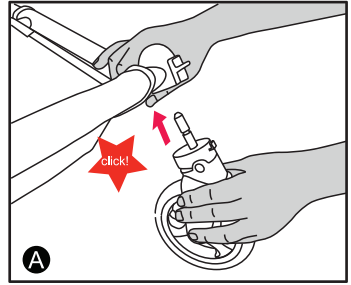

3. Rear Wheels

(5) Attach the rear wheels (L&R) to the stroller as in Fig. A. **CHECK** that wheel is securely attached by pulling on the wheel. For easy transportation and storage, remove the rear wheels by pushing the button shown in Fig. B.

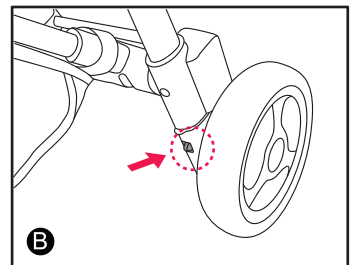
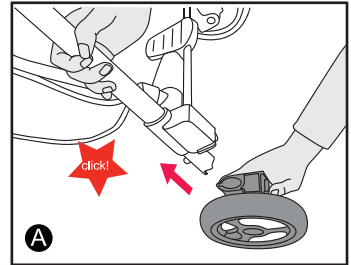

4. To Use Bumper Bar

(6) Assembling and removing the Bumper Bar:

Push the bumper in each slot to install until it clicks into place, as shown in Fig A. Press the buttons on the sides of the Bumper Bar together and pull it off to remove it, as shown in Fig B.

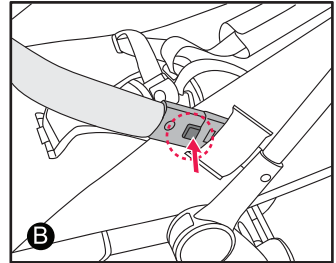
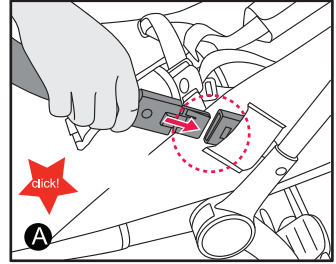

⚠ WARNING: WHEN A CHILD IS IN THE STROLLER, KEEP THE BUMPER BAR ATTACHED TO THE FRAME AT ALL TIMES.

5. Using The Brakes

(7) Parking and loosening the breaks:

Push the breaks levers down to park, as shown in Fig. A

Push up the breaks to loosen the breaks, as shown in Fig. B

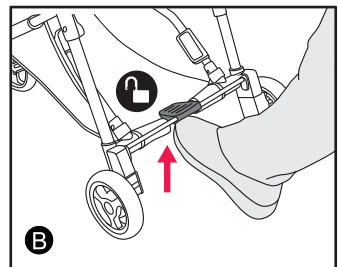
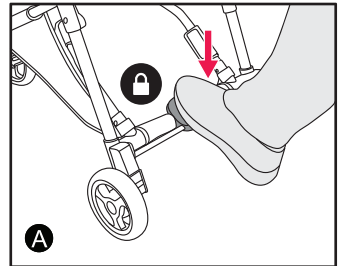

⚠ WARNING: ALWAYS APPLY THE BRAKES WHEN THE STROLLER IS STATIONARY.

6. Swivel Wheel

(8) Push the swivel lock switch down to lock the front wheel in position. Push the swivel lock switch up to allow the wheel to swivel.

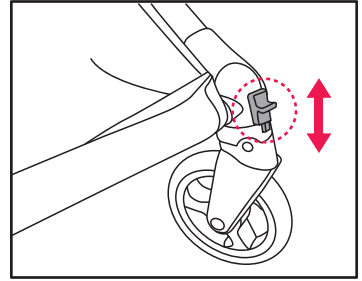

7. Footrest Height Adjustment

(9) Pick up the foot rest to higher position, as shown in Fig. A

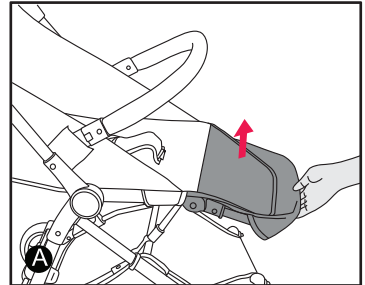

Pull pieces on both sides of the footrest and lowering the footrest to the lower position, as shown in Fig B.

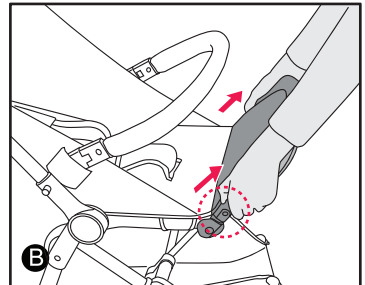

! WARNING: THE FOOTREST FEATURE IS PROVIDED FOR YOUR CHILDS COMFORT. THE FOOTREST IS NOT DESIGNED TO SUPPORT EXTRA WEIGHT. DO NOT ALLOW CHILDREN TO STAND OR SIT ON THE FOOTREST.

8. FOOT BARRIER

WARNING:

For 0 ~ 6 MONTHS BABY, THE FOOT BARRIER HAVE TO BE USED.

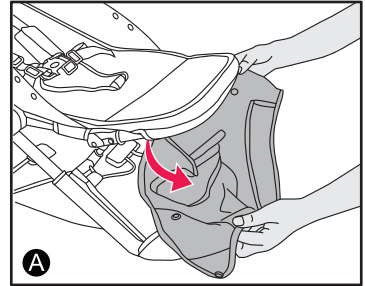

(10) The Foot Barrier is under the Footrest, take it out as shown in Fig. A.

Put the bumper bar go through the Foot Barrier, then attach the bumper bar to stroller frame, as shown in Fig B.

Attached the Foot barrier to the side of the seat with the two Snaps at each side, as shown in Fig. C.

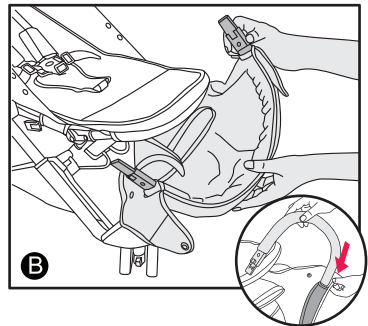

WARNING:

Child may slip into leg openings and strangle.
Never use in reclined position unless the foot barrier is set up in position.

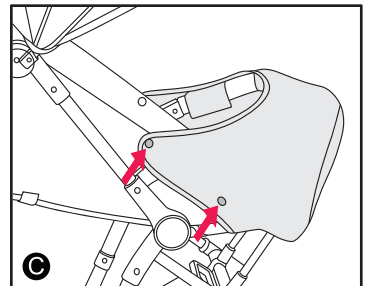

9. Adjusting The Backrest

(11) Adjustment of the reclined and upright position:

Pull the 2 straps as shown in Fig. A to make the backrest move to the upright position.

Pull down the buckle as shown in Fig. B to recline the backrest.

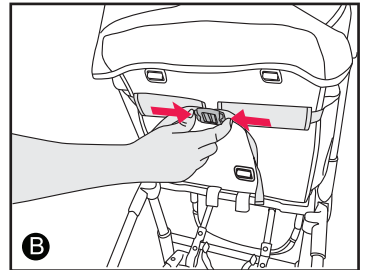
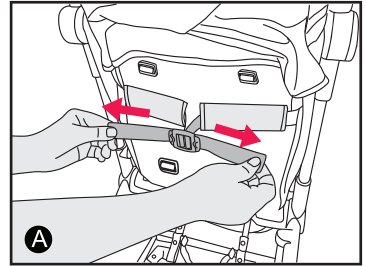

WARNINGS:

- THE UPRIGHT POSITIONS ARE NOT SUITABLE FOR USE WITH CHILDREN LESS THAN 6 MONTHS OLD.
- THE LOWEST RECLINE POSITION SHOULD BE USED TO TRANSPORT BABIES. THE BACKREST CAN BE ADJUSTED TO MORE UPRIGHT POSITION AS THE CHILD GROWS OLDER AND IS ABLE TO SUPPORT ITS HEAD WITHOUT ASSISTANCE.

NOTE: IF THE CHILD IS SITTING IN THE SEAT, SUPPORT THE BACKREST AS IT RECLINES. IF YOU HAVE DIFFICULTY ADJUSTING THE BACKREST YOU MAY NEED TO REMOVE THE CHILD FROM THE SEAT TO ALLOW YOU TO RAISE OR LOWER THE BACKREST WITH EASE.

10. Securing Your Child To The Harness

⚠ WARNING: USE THE HARNESS AT ALL TIMES.
When not in use, disconnect shoulder straps from the waist strap and buckle to prevent strangulation.

A five point harness is provided to restrain your child. Buckle tongues separate for added safety. To reconnect buckle tongues and to secure the child in the harness, please follow the steps below carefully.

(12) Position the shoulder strap tongue. 1 on the top of the waist buckle and 2 on the sides (Fig A).

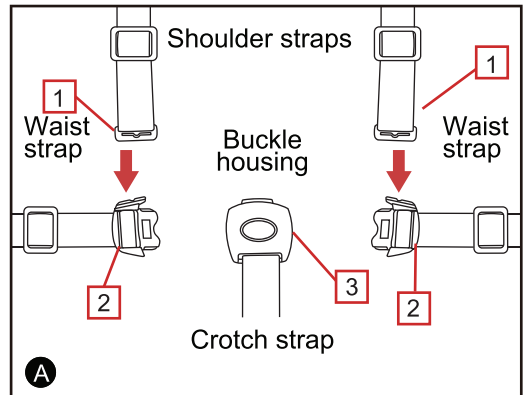

(13) Push both buckle tongues (1+2) into the buckle housing (3) until the buckle tongues lock into position (Fig B).

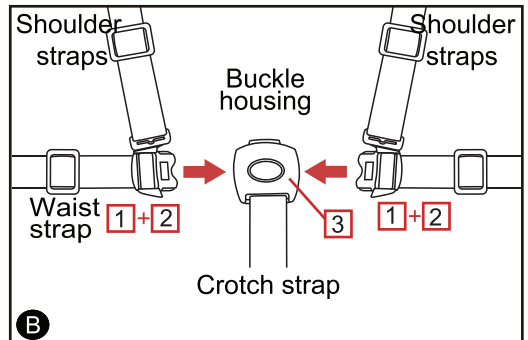

11. Securing Your Child To Harness

(14) Tighten or loosen shoulder and crotch straps by sliding up and down the bar sliders (Fig C).

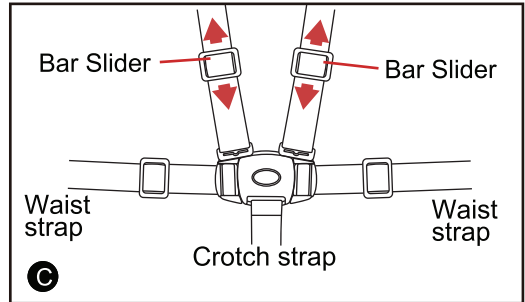

(15) To tighten or loosen the waist straps, hold and lift the 4 bar sliders, then pull the harness strap to adjust to the desired fit. The waist strap needs to fit firmly around the child (Fig D).

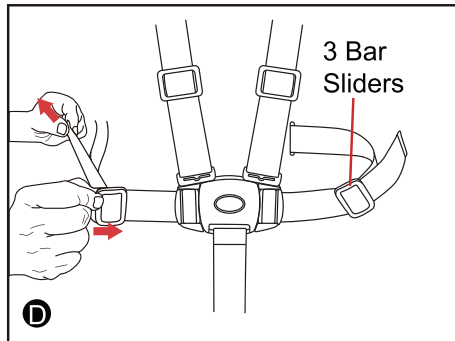

(16) To tighten or loosen the shoulder straps, slide the 3 bar sliders up or down to adjust to the desired fit. Always adjust the harness strap when changing the seating positions of the child (Fig E).



12. Securing Your Child To Harness

(17) To release the buckle, squeeze the top button on the buckle housing with enough pressure so that the buckle tongues can be released (Fig. F).

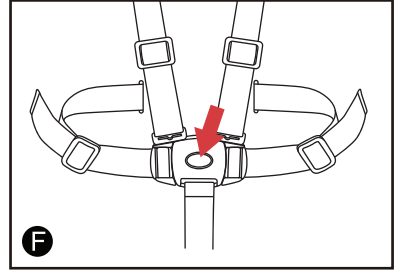

⚠ CAUTION: DO NOT SLIDE 3 BAR SLIDER OVER THE SEWN TAB ON SHOULDER HARNESS.

(18) The stroller seat has 3 sets of harness slots at different heights to accommodate the child. To change the shoulder harness height, push the shoulder harness tongue out of the current harness slot and through fabric slots.

To reposition harness, pull the shoulder harness buckle tongue through the desired slot (Fig G/H).

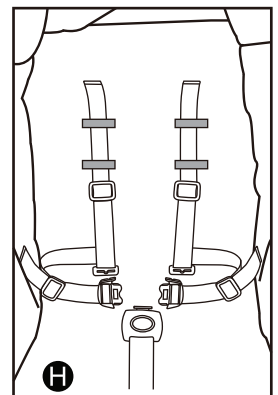
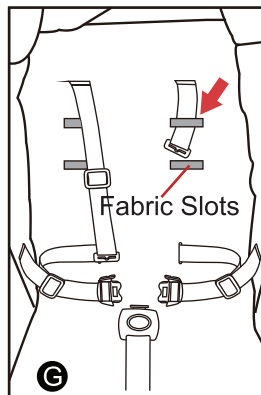

13. To Fold The Stroller

Note: before folding, make sure that the stroller is in the upright position.

(19) Squeeze the button 1 and then squeeze button 2. Then, fold the handle bar downward (Fig A/B).

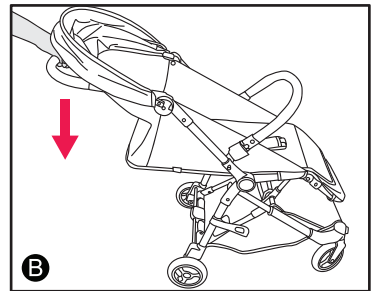
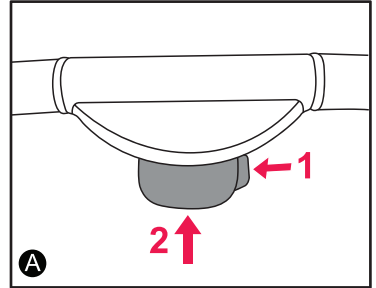

(20) Pull the handle towards the back of the seat, and then forward into the seat as shown in Fig. C. Then, follow Fig. D and continue on the next page for the rest on the instructions.

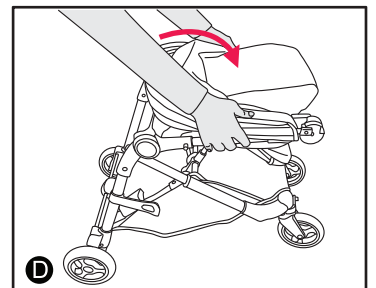
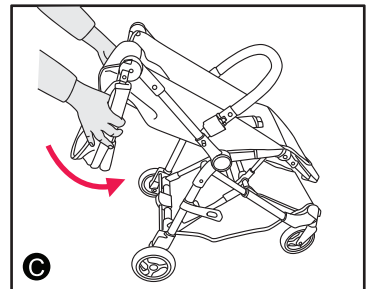

(21) Pull up on the handle and let the frame collapse. (Fig E).

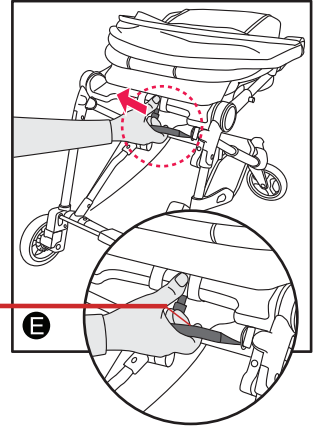

Handle

(22) Make sure the storage latch clicks into place. Stroller can stand up after fold (Fig F).

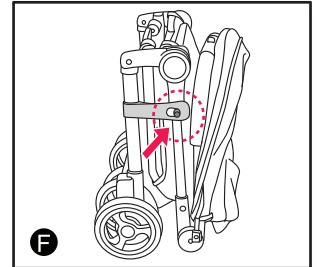

14. To Lift and Carry The Stroller

To lift or carry the stroller, ensure that the storage latch is engaged. Press the spring hook to attach the shoulder strap on stroller at both sides and you can carry the stroller on your shoulder conveniently.

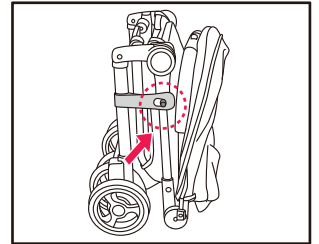



1532, S. Washington Avenue
Piscataway, NJ 08854
E-mail: info@evolurbaby.com

www.evolurbaby.com

Follow us on



@EvolurBaby



@evolurbaby

to get your nursery featured on our social media.

Enter our monthly giveaway!

Simply scan the QRcode to register.



Chat with us!

For any questions or concerns or feedback.

